

Operating Instructions

Sartorius

Description of the Interface
for GD, GE and TE Balances/Scales

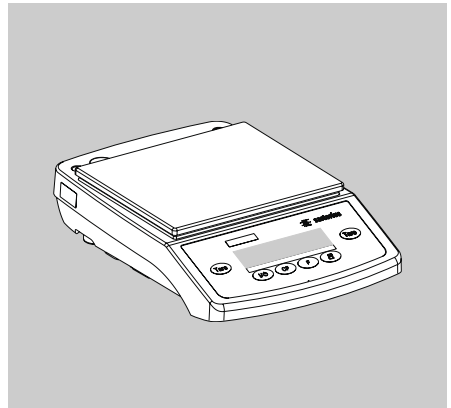
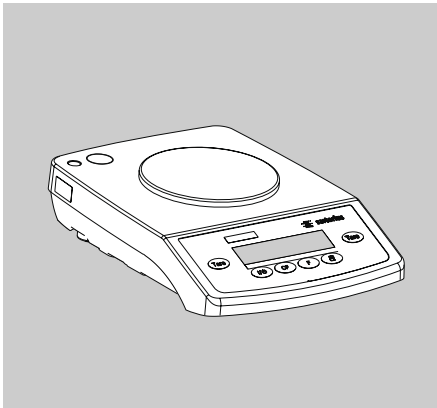
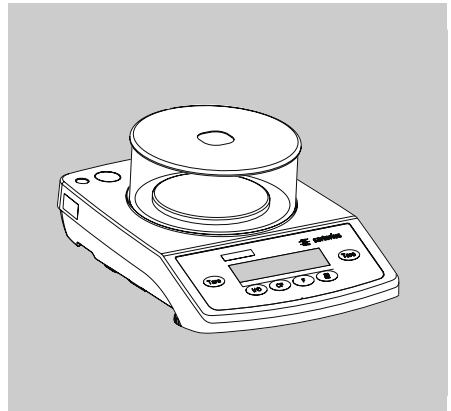
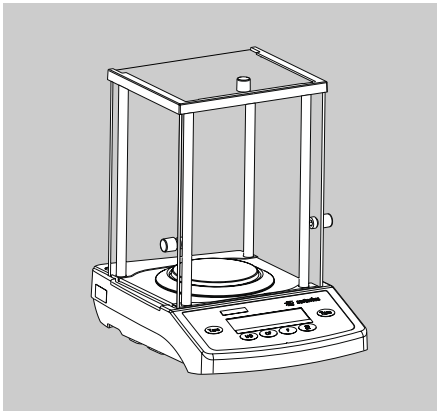

Contents

2	Contents
2	Intended Use
2	Configuring the Interface Parameter Settings (Menu)
3	Data Output Functions
3	Printing a Data Record
5	Interface Description
5	Data Output Format
9	Data Input Format
12	Cabling Diagram

Intended Use

The interface can be used to connect the balance/scale to a computer (or other peripheral device).

You can use a computer to change, start and monitor balance/scale functions and applications.

Available Features

- Type of interface: Serial interface
- Operating mode: Full duplex
- Standard: RS-232
- Transmission rates: 150, 300, 600, 1,200, 2,400, 4,800, 9,600 baud
- Parity: Mark, space, odd, even
- Character format: Start bit, 7-bit ASCII, parity, 1 or 2 stop bits
- Handshake:
 - 2-wire interface: via software (XON/XOFF)
 - 4-wire interface: via hardware (CTS/DTR)
- Protocol: SBI (Sartorius Balance Interface)
- Data output format of the balance/scale: 16 or 22 characters

Configuring the Interface

Parameter Settings (Menu)

Please refer to the installation and operating instructions supplied with your balance/scale.

Data Output Functions

Printing a Data Record

Purpose

You can generate a printout of weights as well as other measured values and IDs for documentation purposes. You can format the printout to meet individual requirements.

Available Features

Print individual values

Line format: You can configure a data ID code of up to 6 characters for each of the values printed; this data ID code is printed at the beginning of a line

Printouts are generated automatically or by pressing $\left(\frac{\square}{\square}\right)$, depending on or regardless of the balance/scale stability parameter.

You can have the following values output automatically when using the application programs if menu code 7.1.2 (printout with data ID codes) is configured:

- Second tare memory: last net value
- Counting: Reference weight for one piece (average piece weight)
- Weighing in percent:
Reference weight for the percentage selected
- Averaging: Result of measurement

Examples of Data Records:

Printout without Data ID Codes (Menu Code 7.1.1):

The value currently displayed is printed (weight or calculated value with unit)

+	1530.0	g	Weight in grams
+	58.562	oz t	Weight in Troy ounces
+	253	pcs	Piece count
+	88.2	%	Percentage
+	105.8	o	Calculated value

Printout with Data ID Codes (Menu Code 7.1.2):

The current value displayed can be printed with a data ID code of up to 6 characters at the beginning of a line. You can use this data ID code, e.g., to designate a weight readout as a net weight (N) or a calculated value as a quantity (Qnt).

N	+	153.0	g	Current net weight
N1	+	153.0	g	Current net weight (with data in 2nd tare memory)
T1	+	10.2	g	Value in 2nd tare memory
Qnt	+	253	pcs	Calculated quantity (piece count)
Prc	+	88.2	%	Calculated percentage
Res	+	153.0	g	Calculated result

Print Application Parameters (Menu Code 7.1.2):

You can generate a printout of one or more of the values configured for initialization of an application as soon as you initialize the balance/scale.

wRef	+	1.432	g	Counting: average piece weight
Wxx%	+	120.12	g	Weighing in percent: reference weight for the selected percentage

Auto Print (Menu Code 6.1.3 or 6.1.4):

You can have the weight readout printed automatically. The display update interval depends on the operating status of the balance/scale and on the balance/scale model.

N	+	153.9	g	Net weight
Stat				Display blank
Stat		L		Display underload
Stat		H		Display overload

Interface Description

Factory Settings

Transmission rate: 1,200 baud (5. 1. 4)

Parity: Odd (5. 2. 3)

Stop bits: 1 stop bit (5. 3. 1)

Handshake:

Hardware, 1 character after CTS (5. 4. 3)

Protocol: Standard SBI (5. 5. 1)

Print manually/automatically:

Manual after stability (5. 1. 2)

Line format:

For other applications (7. 1. 2)

Data Output Format

You can output the values displayed in the measured value line and the weight unit with or without a data ID code.

Example: Without data ID code

+ 253 pcs

Example: With data ID code

Qnt + 253 pcs

Configure this parameter in the Setup menu
(Menu: Printout format 7. 1. 1 or 7. 1. 2).

The output without data ID code has 16 characters;
with data ID code, 22 characters.

Output Format With 16 Characters

Display segments that are not activated are output as spaces.
 Characters without a decimal point are output without a decimal point.

The following characters can be output, depending on the characters displayed on the balance/scale:

Normal Operation

Position	1	2	3	4	5	6	7	8	9	10	11	12	13	14	15	16
	+	*	D	D	D	D	D	D	D	D	*	U	U	U	CR	LF
or	-	*	*	*		
or	*	*	*	*	*	*	*	*	*	*	*					
or		0	0	0	0	0	0	0								

- *: Space
- D: Digit or displayed character
- U: Unit symbol
- .: Decimal point
- 0: Zero
- CR: Carriage return
- LF: Line feed

Special Codes

Position	1	2	3	4	5	6	7	8	9	10	11	12	13	14	15	16
	*	*	*	*	*	*	-	-	*	*	*	*	*	*	CR	LF
or							H	*								
or							L	*								

- *: Space
- -: Final readout mode
- H: Overload
- L: Underload

Error Codes

Position	1	2	3	4	5	6	7	8	9	10	11	12	13	14	15	16
	*	*	*	E	*	*	*	*	#	#	#	*	*	*	*	CR LF

- *: Space
- # # #: Error code number

Example: Data output + 1255.7 g at stability

Position	1	2	3	4	5	6	7	8	9	10	11	12	13	14	15	16
	+	*	*	*	1	2	5	5	.	7	*	g	*	*	CR	LF

- Position 1: Plus or minus sign or space
- Position 2: Space
- Position 3 –10: Weight with a decimal point; leading zeros = space
- Position 11: Space
- Position 12 –14: Unit symbol or space
- Position 15: Carriage return
- Position 16: Line feed

Output Format with 22 Characters

When data with an ID code is output, the ID code consisting of 6 characters precedes the data with the 16-character format. These 6 characters identify the following value.

1	2	3	4	5	6	7	8	9	10	11	12	13	14	15	16	17	18	19	20	21	22
I	I	I	I	I	I	+	*	D	D	D	D	D	D	D	D	*	U	U	U	CR	LF
		*	*	*	*	-	*	*	*			
						*	*	*	*	*	*	*	*	*	*						
									0	0	0	0	0	0							

- I: ID code character
- U: Unit symbol
- *: Space
- CR: Carriage return
- D: Digit or displayed character
- LF: Line feed
- .: Decimal point
- 0: Zero

Special Codes

1	2	3	4	5	6	7	8	9	10	11	12	13	14	15	16	17	18	19	20	21	22
S	T	A	T	*	*	*	*	*	*	*	*	-	-	*	*	*	*	*	*	*	CR LF
												H *									
												L *									

*: Space
 -: Final readout mode (readout has not yet stabilized)
 H: Overload
 L: Underload

Error Codes

1	2	3	4	5	6	7	8	9	10	11	12	13	14	15	16	17	18	19	20	21	22
S	T	A	T	*	*	*	*	*	E	r	r	*	#	#	#	*	*	*	*	CR LF	

*: Space
 # # #: Error code number

ID code characters	Meaning
S t a t	Status
N	Net N
N1	Net N1 (when data in the 2nd tare memory)
Q n t	Counting: quantity (piece count)
P r c	Weighing in percent: percentage
R e s	Calculation, averaging: result
w R e f	Automatic printout: average piece weight
W x x %	Automatic printout: reference percentage weight

Data Input Format

You can connect a computer to your balance/scale to send commands via the balance/scale interface port to control balance/scale functions and applications.

A control command can have up to 4 characters. Each character must be transmitted according to the settings configured in the Setup menu for data transmission.

Format for Control Commands

Format : Esc ! CR LF

Esc: Escape
!: Command char.
CR: Carriage return (optional)
LF: Line feed (optional)

Command character ! Meaning

K	Weighing mode 1
L	Weighing mode 2
M	Weighing mode 3
N	Weighing mode 4
O	Block keys
P	Print
R	Release keys
S	Restart
T	Tare and zero (combined)
U	Tare ("tare only")
V	Zero
W	External calibration/adjustment (depends on menu setting)

Synchronization

During data communication between the balance/scale and an on-line device (computer), messages consisting of ASCII characters are transmitted via the interface. For error-free data communication, the parameters for baud rate, parity, handshake mode and character format must be the same for both units.

You can set these parameters in the Setup menu so that they match those of the on-line device. You can also define parameters in the balance/scale to make data output dependent on various conditions. The conditions that can be configured are described for each of the application programs.

If you do not plug a peripheral device into the balance/scale interface port, this will not generate an error message.

Handshake

The balance/scale interface (Sartorius Balance Interface = SBI) has transmit and receive buffers. You can define the handshake parameter in the Setup menu:

- Hardware handshake (CTS/DTR)
- Software handshake (XON, XOFF)

Hardware Handshake

With a 4-wire interface, 1 or 2 more characters can be transmitted after CTS.

Software Handshake

The software handshake is controlled via XON and XOFF. When a device is switched on, XON must be transmitted to enable any connected device to communicate.

Activating Data Output

You can define the data output parameter so that output is activated either when a print command is received or automatically and synchronously with the balance/scale display (see application program descriptions and auto-print setting).

Data Output by Print Command

The print command can be transmitted by pressing  or by a software command (Esc P).

Automatic Data Output

In the “auto print” operating mode, data is output to the interface port without a print command. You can choose to have data output automatically and synchronously with the balance/scale display at defined print intervals with or without the stability parameter. Whichever parameter you select, the data will be output as the readouts appear on the balance/scale display. The display update frequency depends on the setting for “Adapting the Filter” (code 1.1.x.).

When the “auto print” menu code is activated, this function starts immediately after the balance/scale has been turned on.

Pin Assignment Chart

Please refer to the installation and operating instructions supplied with your balance/scale.

Cabling Diagram

Diagram for interfacing a computer or different peripheral device to the balance/scale using the RS-232/V24 standard and cables up to 15 m (~50 ft.) long

Balance/Scale

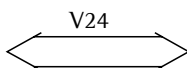
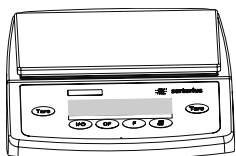

Peripheral Device

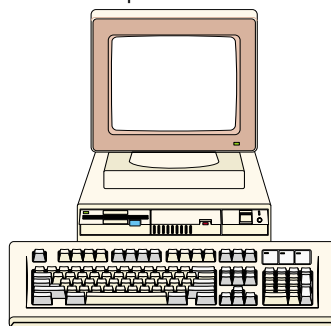

PC

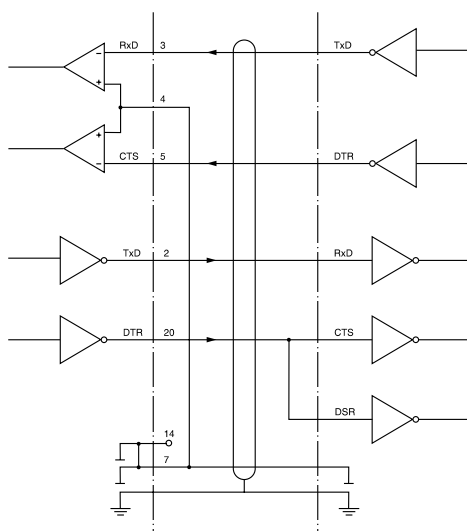

25 pol.	or	9 pol.
2		3
20		4
3		2
5		8
6		6
7		5

Type of cable: AWG 24 specification

Sartorius AG
Weender Landstrasse 94–108
37075 Goettingen, Germany

Phone +49.551.308.0
Fax +49.551.308.3289
www.sartorius.com

Copyright by Sartorius AG,
Goettingen, Germany.
All rights reserved. No part
of this publication may
be reprinted or translated in
any form or by any means
without the prior written
permission of Sartorius AG.
The status of the information,
specifications and illustrations
in this manual is indicated
by the date given below.
Sartorius AG reserves the
right to make changes to
the technology, features,
specifications and design of
the equipment without notice.

Status:
July 2003, Sartorius AG,
Goettingen, Germany